

NOTICE!!

These documents have been scanned!

Do not place un-scanned documents beneath this notice!

Do not remove this notice from this file!

GPO Jacket No. 560-102
Print Order 61540
Rise Business Services, LLC
Job=AZ15 6/3/2019



Box Number= AZ15109



Claim Begin-End: AMC368687-AMC368687

1 Initial Receipt



AZ15109-2

AMC368661-AMC368895

**United States Department of the Interior
Bureau of Land Management**

BUSINESS & SUPPORT SVCS DIV
ONE N CENTRAL AVE
PHOENIX, AZ 85004 -2203
Phone: (602) 417-9200

Receipt	
No:	1202104

ENTERED INTO COMPUTER
DEC 22 2005 *RS*

Transaction #: 1242551
Date of Transaction: 12/15/2005

CUSTOMER: ZERAD INC
425 E GREENWAY DR
TEMPE, AZ 85282

LINE #	QTY	DESCRIPTION	REMARKS	UNIT PRICE	TOTAL
1	1.00	LOCATABLE MINERALS / MINING CLAIMS-NEW, UNADJUD, ONE OR MORE AUTH NOS / NEW MINING CLAIM LOCATION FEE \$25 (1993) CASES: AMC368687/\$25.00		- n/a -	25.00
2	1.00	LOCATABLE MINERALS / MINING CLAIMS-NEW, UNADJUD, ONE OR MORE AUTH NOS / NEW MINING CLM MAINT FEE \$125 (1993) CASES: AMC368687/\$125.00		- n/a -	125.00
3	1.00	LOCATABLE MINERALS / MINING CLAIMS-NEW, UNADJUD, ONE OR MORE AUTH NOS / NEW MINING CLAIM PROCESSING FEE \$15 (1930) CASES: AMC368687/\$15.00		- n/a -	15.00
TOTAL:					\$165.00

PAYMENT INFORMATION					
1	AMOUNT:	\$165.00	POSTMARKED:	12/05/2005	
	TYPE:	CHECK	RECEIVED:	12/12/2005	
	CHECK NO:	172			
	NAME:	ZERAD INC 425 E GREENWAY DR TEMPE AZ 85282			

REMARKS

NOTICE SENT

This receipt was generated by the automated BLM Collections and Billing System and is a paper representation of a portion of the official electronic record contained therein.

NOTICE!!

These documents have been scanned!

Do not place un-scanned documents beneath this notice!

Do not remove this notice from this file!

GPO Jacket No. 560-102
Print Order 61540
Rise Business Services, LLC
Job=AZ15 6/3/2019



Box Number= AZ15109



Claim Begin-End: AMC368687-AMC368687

2 Correspondence



AZ15109-2 AMC368661-AMC368895

**NO
DOCUMENTS
FOUND**

NO DOCUMENTS FOUND
NO DOCUMENTS FOUND

NOTICE!!

These documents have been scanned!

Do not place un-scanned documents beneath this notice!

Do not remove this notice from this file!

GPO Jacket No. 560-102
Print Order 61540
Rise Business Services, LLC
Job=AZ15 6/3/2019



Box Number= AZ15109



Claim Begin-End: AMC368687-AMC368687

3 Transfers



AZ15109-2

AMC368661-AMC368895

368687

AFTER RECORDING RETURN TO:

Edward G Winbourne
4136 West Bradshaw Creek Lane
Phoenix, AZ 85087

SPACE ABOVE IS FOR RECORDERS USE

QUIT CLAIM DEED

On 14 September 2020 **THE GRANTOR(S)** Zeco Inc.
for and in consideration of Five thousand dollars (\$ 5000.00) and/or
other good and valuable consideration conveys, releases, and quit claims to **GRANTEE(S)**
The Daisy Mountain rock and Mineral Club Inc.

(Name and Address)

the following described unpatented mining claims, situated in the State of
Arizona, in the County of Yavapai.

BLM SERIAL NUMBER	CLAIM NAME	LEGAL DESCRIPTION
AMC368687	Blue Owl Mine	Prospect is located NW1/4 SW1/4, section 23, T.8N., R. 4 W., gitta & Salt River Meridian, Yavapia County, Arizona
		34 01.25 N 112 38 68 W
		34 01 . 27N 112 38 68 W
		34 01 31.7N 112 38 41.2W
		34 01 24N 112 38 55.0W

Grantor does hereby convey, release and quitclaim 100 percent of the Grantor's rights, title, and interest in and to the above described property and premises to the Grantee(s), and to the Grantee(s) heirs, and assigns forever, so that neither Grantor(s) nor Grantor(s) heirs, legal representatives, or assigns shall have, claim or demand any right or title to the property, premises, or appurtenances, or any part thereof.

Grantor Signature(s) *Richard J. McManis*

Date: SEP. 15, 2020

4806251

RECEIVED
BLM AZ STATE OFFICE
2020 SEP 18 A 11:35
PHOENIX ARIZONA

INTEREST
SEP 28 2020
BY: *Rm*

by Edward J. Wilcoxon

M E Rutherford
Notary Public

Admin
Title (and Rank)

My Commission Expires: March 19, 2024

Notary Address

2865 Little Hawk Tr
Overgaard, AZ 85933

Megan E Rutherford
Printed Name of Notary Republic
Notary Public for the State of Arizona
Residing at: Arizona
My Commission Expires: March 19, 2024

(Notary Seal)

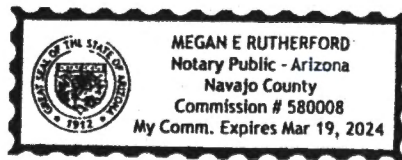

PHOENIX, ARIZONA

2020 SEP 18 A 11:35

RECEIVED
BLM AZ STATE OFFICE

16 September 2020

My Club has purchased the Blue Owl Mine in Wickenburg AZ, AMC 368687.

The previous owner is: Zeco Inc.

425 E Greenway Drive

Tempe, AZ 85282

The new owner is: The Daisy Mountain Rock and Mineral Club Inc.

4136 West Bradshaw Creek Lane

Phoenix, AZ 85087

New Owner contact number: 978-460-1528

Yours truly,

Edward G Winbourne, President: Daisy Mountain Rock and Mineral Club Inc.



RECEIVED
BLM AZ STATE OFFICE
2020 SEP 18 A 11:35
PHOENIX, ARIZONA

WINBOURNE, ED
623-551-1305
C/O POSTNET AZ115
3655 W. ANTHEM WAY
ANTHEM AZ 85086

1 LBS

1 OF 1

DWT: 13,10,1

SHIP TO:
9784601528
BUREAU OF LAND MANAGEMENT
SUITE 800
1 N CENTRAL AVE
PHOENIX AZ 85004



AZ 850 9-10



UPS GROUND

TRACKING #: 1Z E00 947 03 9846 8101



BILLING: P/P

Reference No. 1: 0166522



XOL 20.08 05

NV45 31.0R 07/2020



SEE NOTICE ON REVERSE regarding UPS terms, and notice of limitation of liability. Where allowed by law, shipper authorizes UPS to act as forwarding agent for export related and customs purposes. It is reported from the US, which certifies that the commodity, technology or software were exported from the US in accordance with the Export Administration Regulations. (Where contrary to law is prohibited.) 950-003 1119

BUREAU OF LAND MANAGEMENT
1 N CENTRAL AVE
STE 800
PHOENIX AZ 85004

P: BROWN S: ORANGE I:
1004 - FDR

1ZE00947039846 8101

HLCDVH 82PH078UDC SEP 17 04:41:54 2020
US 8501 NIP 80.3.0 ZENRAZ1450



RECEIVED
BLM AZ STATE OFFICE
2020 SEP 18 A 11:35
PHOENIX, ARIZONA

Express Envelope

**United States Department of the Interior
Bureau of Land Management
DIV OF LANDS, MINRLS & ENERGY
ONE N CENTRAL AVE
PHOENIX, AZ 85004 -4427
Phone: 602-417-9200**

Receipt	
No:	4806251

Transaction #: 4933688	
Date of Transaction: 09/18/2020	
CUSTOMER:	
THE DAISY MOUNTAIN ROCK AND MINERAL CLUB INC 4136 W BRADSHAW CREEK LN PHOENIX,AZ 85087-5810 US	

LINE #	QTY	DESCRIPTION	REMARKS	UNIT PRICE	TOTAL
1	1.00	LOCATABLE MINERALS / MINING CLAIMS- NOT NEW-UNADJUD,ONE AUTH NO. ONLY / MINING CLAIM MONEY RECEIVED CASES: AMC368687/\$15.00	TRF	- n/a -	15.00
TOTAL:					\$15.00

PAYMENT INFORMATION			
1	AMOUNT:	15.00	POSTMARKED: N/A
	TYPE:	CHECK	RECEIVED: 09/18/2020
	CHECK NO:	0052307414	
	NAME:	THE DAISY MOUNTAIN ROCK AND MINERAL CLUB INC 4136 W BRADSHAW CREEK LN PHOENIX AZ 85087-5810 US	

REMARKS

This receipt was generated by the automated BLM Collections and Billing System and is a paper representation of a portion of the official electronic record contained therein.

Amc 368687

QUIT CLAIM DEED

RECEIVED
PDO

10 NOV -2 AM 11:56

BUREAU OF LAND MGMT
PHOENIX, ARIZONA

GRANTOR

Zerad, Inc., an Arizona corporation

GRANTEE

Zerad, LLC, an Arizona limited liability company

For valuable consideration, the sufficiency of which is hereby acknowledged, the Grantors quit claim to Grantee all right, title, and interest of Grantors in the real property situated in Yavapai County, Arizona described below, together with all rights and privileges appurtenant or to become appurtenant to Subject Real Property.

Mining claim AMC368687 (Blue Owl) as filed with the US Department of the Interior, Bureau of Land Management, Phoenix District

Dated this 28th day of October, 2010

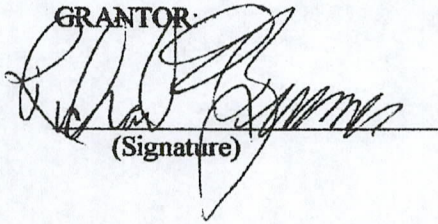
GRANTOR:

(Signature)

Richard E. Zimmermann,
President
Zerad, Inc.

RECEIVED
BLMAZ STATE OFFICE
2010 NOV 23 A 9:35
PHOENIX, ARIZONA

STATE OF ARIZONA)
) ss.
County of Maricopa)

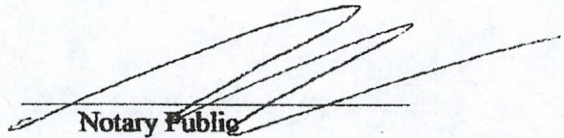
This instrument was acknowledged before me this 28th day of October, 2010, by Richard E. Zimmermann.

Notary Public

My Commission Expires: 5/19/13

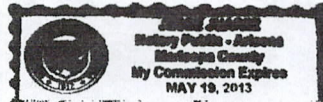

Quit Claim Deed Executed by Richard E. Zimmermann, President, Zerad, Inc.

ENTERED INTO COMPUTER

12/1/10 AT

MEMO
Oct 29, 2010

RECEIVED
10/29/2010 11:51 AM
PHOENIX, ARIZONA

To: Mike Rice

From: Dick Zimmermann

Reference: AMC 368687 (Blue Owl)

The company holding the claim has been changed from a corporation to a LLC.

A deed transferring the claim is enclosed.

The application for a new exploration permit sent to you recently already used Zerad LLC as the applicant rather than Zerad, Inc.

RECEIVED
BLM AZ STATE OFFICE
2010 NOV 23 A 9:35
PHOENIX, ARIZONA

Memo
Nov. 15th
Zerad, LLC

RECEIVED
RFD
10 NOV 16 PM 1:31
BUREAU OF LAND MGMT
PHOENIX, ARIZONA

To: Mike Rice

From: Dick Zimmermann

Previously, I sent you a deed transferring our claim from Zerad Inc. to Zerad LLC. Looking at you website, I noticed there is a \$10 fee for such a transfer. A check for \$10 is enclosed.

Page 2 of you online instructions includes the following statement:

Casual use means activities ordinarily resulting in no or negligible disturbance of the public land or resourced. Casual use does not include the use of mechanized earth moving equipment, *truck mounted drilling equipment*, or -----

With neither our notice nor plan of operations approved, I understand that we cannot operate our tractors on the claim. However, based on the above paragraph, I assume we can continue to use rock drills that are not truck mounted along with hand tools.

We have been using a 60 pound class hand held pneumatic drill. We do not use explosives. We use mechanical wedges and expanding material sold under the Dexpan trade name.

RECEIVED
BLM AZ STATE OFFICE
2010 NOV 23 A 9:35
PHOENIX, ARIZONA

United States Department of the Interior
Bureau of Land Management
 LANDS/RECREATION & PLANNING
 ONE N CENTRAL AVE
 PHOENIX, AZ 85004 -2203
 Phone:

Receipt

No:

2251052

Transaction #: 2322222	
Date of Transaction: 11/23/2010	
CUSTOMER:	
	ZERAD INC 425 E GREENWAY DR TEMPE, AZ 85282-6938 US

LINE #	QTY	DESCRIPTION	REMARKS	UNIT PRICE	TOTAL
1	1.00	LOCATABLE MINERALS / MINING CLAIMS-NOT NEW-UNADJUD, ONE AUTH NO. ONLY / MINING CLAIM MONEY RECEIVED CASES: AMC368687/\$10.00	TRF/1	- n/a -	10.00
TOTAL:					\$10.00

PAYMENT INFORMATION			
1	AMOUNT:	10.00	POSTMARKED: 11/15/2010
	TYPE:	CHECK	RECEIVED: 11/23/2010
	CHECK NO:	199	
	NAME:	ZERAD INC 425 E GREENWAY DR TEMPE AZ 85282-6938 US	

REMARKS

This receipt was generated by the automated BLM Collections and Billing System and is a paper representation of a portion of the official electronic record contained therein.

NOTICE!!

These documents have been scanned!

Do not place un-scanned documents beneath this notice!

Do not remove this notice from this file!

GPO Jacket No. 560-102
Print Order 61540
Rise Business Services, LLC
Job=AZ15 6/3/2019



Box Number= AZ15109



Claim Begin-End: AMC368687-AMC368687

4 Annual Filings



AZ15109-2

AMC368661-AMC368895

DEPARTMENT OF THE INTERIOR
BUREAU OF LAND MANAGEMENT
MINING CLAIMS

Run Date/Time: 7/11/2019

MC Maintenance Fees Paid Through the BLM Pay Portal
(by Date Paid)

Page 16 Of 61

CBS Receipt: 4397293

Printed For Lead File # AMC368687

Agency Tracking ID: 1552513524

Assessment Year: 2020

Number of BLM Serial Nr: 1

Paid On: 3/13/2019

Total Amount Paid: \$155.00

Claim Name	BLM Serial No	Lead File No	Amount Paid
BLUE OWL	AMC368687	AMC368687	\$155.00

United States Department of the Interior
Bureau of Land Management
 BUSINESS & SUPPORT SVCS DIV
 ONE N CENTRAL AVE SUITE 800
 PHOENIX, AZ 85004 -4427
 Phone: 602-417-9200

Receipt

No: 4397293

Transaction #: 4515600	
Date of Transaction: 03/13/2019	
CUSTOMER:	
ZECO 3024 W WINDSONG ST APACHE JUNCTION, AZ 85120 US	

LINE #	QTY	DESCRIPTION	REMARKS	UNIT PRICE	TOTAL
1	1.00	LOCATABLE MINERALS / MINING CLAIMS- NOT NEW-UNADJUD, ONE AUTH NO. ONLY / MINING CLAIM MONEY RECEIVED CASES: AMC368687/\$155.00		- n/a -	155.00
TOTAL:					\$155.00

PAYMENT INFORMATION			
NOTE: Items will appear on credit card statement as "BLM O Mining Claim".			
1	AMOUNT:	155.00	POSTMARKED: N/A
	TYPE:	CREDIT CARD	RECEIVED: 03/13/2019
	NAME:	ZECO 3024 W WINDSONG ST APACHE JUNCTION AZ 85120 US	
	CARD NO:	XXXXXXXXXXXX0578	AUTH CODE: 041882
	NAME ON CARD:	ZECO	
	SIGNATURE:	INTERNET	

REMARKS

This receipt was generated by the automated BLM Collections and Billing System and is a paper representation of a portion of the official electronic record contained therein.

UNITED STATES
DEPARTMENT OF THE INTERIOR
BUREAU OF LAND MANAGEMENT

CREDIT CARD PAYMENT
For Mining Claim Maintenance Fee

THIS IS A CHANGE OF ADDRESS

TELEPHONE SUBMISSION - ACCURACY OF THE BELOW INFORMATION IS THE RESPONSIBILITY OF THE CLAIMANT/OWNER

NAME Richard E Zimmernann
ADDRESS 3024 W. Wundberg St
CITY AS STATE AZ ZIP 85120
PHONE # 480 - 839 6390

SEND RECEIPT TO Above address 928-535-5425
 Other (Include Name and Mailing Address):

AMC NUMBER
AMC 368687

CLAIM/SITE NAME

add'l \$10⁰⁰
of Claim/Site 1
x 165.00 Each
\$ 10⁰⁰ Total Charged PER (INITIALS)

RECEIPT # 4539466

DATE STAMP

RECEIVED
BLM STATE OFFICE
2019 AUG 22 A 8:51
TULSA, ARIZONA

***** FOR OFFICIAL USE ONLY *****
DATE _____ INITIALS _____ VERIFIED _____

ENTERED
AUG 23 2019
BY: [Signature]

United States Department of the Interior
Bureau of Land Management
 DIV OF LANDS, MINRLS & ENERGY
 ONE N CENTRAL AVE
 PHOENIX, AZ 85004 -4427
 Phone: 602-417-9200

Receipt	
No:	4539466

Transaction #: 4660410
Date of Transaction: 08/22/2019

CUSTOMER:	
RICHARD E ZIMMERMANN 3024 W WINDSONG ST APACHE JUNCTION, AZ 85120-1508 US	

LINE #	QTY	DESCRIPTION	REMARKS	UNIT PRICE	TOTAL
1	1.00	LOCATABLE MINERALS / MINING CLAIMS- NOT NEW-UNADJUD, ONE AUTH NO. ONLY / MINING CLAIM MONEY RECEIVED CASES: AMC368687/\$10.00	2020 MAINT ADDL FEES/1	- n/a -	10.00
TOTAL:					\$10.00

PAYMENT INFORMATION			
NOTE: Items will appear on credit card statement as "Bureau of Land Mgmt CO".			
1	AMOUNT:	10.00	POSTMARKED: N/A
	TYPE:	CREDIT CARD	RECEIVED: 08/22/2019
	NAME:	ZIMMERMANN, RICHARD E 3024 W WINDSONG ST APACHE JUNCTION AZ 85120-1508 US	
	CARD NO:	XXXXXXXXXXXX0578	AUTH CODE: 065835
	NAME ON CARD:	RICHARD E ZIMMERMANN	
	SIGNATURE:	OVER THE PHONE	

REMARKS

This receipt was generated by the automated BLM Collections and Billing System and is a paper representation of a portion of the official electronic record contained therein.

Run Date: 07/23/18

Run Time: 04:31 PM

**DEPARTMENT OF THE INTERIOR
BUREAU OF LAND MANAGEMENT
MINING CLAIMS**

MC Maintenance Fees Paid Through the BLM Pay Portal

CBS Receipt: 4129759

Printed For Lead File # AMC368687

Agency Tracking ID: 1522786911

Assessment Year: 2019

Number of BLM Serial Nr: 1

Paid On: 04/03/2018

Total Amount Paid: \$155.00

Claim Name	BLM Serial No	Lead File No	Amount Paid
BLUE OWL	AMC368687	AMC368687	\$155.00

United States Department of the Interior
Bureau of Land Management
 BUSINESS & SUPPORT SVCS DIV
 ONE N CENTRAL AVE SUITE 800
 PHOENIX, AZ 85004 -4427
 Phone: 602-417-9200

Receipt

No: 4129759

Transaction #: 4243388	
Date of Transaction: 04/03/2018	
CUSTOMER:	
RICHARD E ZIMMERMANN 3024 W WINDSONG ST APACHE JUNCTION, AZ 85120 US	

LINE #	QTY	DESCRIPTION	REMARKS	UNIT PRICE	TOTAL
1	1.00	LOCATABLE MINERALS / MINING CLAIMS- NOT NEW-UNADJUD, ONE AUTH NO. ONLY / MINING CLAIM MONEY RECEIVED CASES: AMC368687/\$155.00		- n/a -	155.00
TOTAL:					\$155.00

PAYMENT INFORMATION				
NOTE: Items will appear on credit card statement as "BLM O Mining Claim".				
1	AMOUNT:	155.00	POSTMARKED:	N/A
	TYPE:	CREDIT CARD	RECEIVED:	04/03/2018
	NAME:	RICHARD E ZIMMERMANN 3024 W WINDSONG ST APACHE JUNCTION AZ 85120 US		
	CARD NO:	XXXXXXXXXXXX0578	AUTH CODE:	034832
	NAME ON CARD:	RICHARD E ZIMMERMANN		
	SIGNATURE:			

REMARKS

This receipt was generated by the automated BLM Collections and Billing System and is a paper representation of a portion of the official electronic record contained therein.

Run Date: 08/21/17

Run Time: 09:47 AM

**DEPARTMENT OF THE INTERIOR
BUREAU OF LAND MANAGEMENT
MINING CLAIMS**

MC Maintenance Fees Paid Through the BLM Pay Portal

CBS Receipt: 3943371

Printed For Lead File # **AMC368387**

Agency Tracking ID: 1503012947

Assessment Year: 2018

Number of BLM Serial Nr: 1

Paid On: 08/17/2017

Total Amount Paid: \$310.00

Claim Name	BLM Serial No	Lead File No	Amount Paid
THUNDER CANYON #23	AMC368388	AMC368387	\$310.00

United States Department of the Interior
Bureau of Land Management
 BUSINESS & SUPPORT SVCS DIV
 ONE N CENTRAL AVE SUITE 800
 PHOENIX, AZ 85004 -4427
 Phone: 602-417-9200

Receipt

No: 3943371

Transaction #: 4053051	
Date of Transaction: 08/17/2017	
CUSTOMER:	
GRAHAM C WILLIAMS 3325 MOUNT MCKINLEY DR SAN JOSE, CA 95127 US	

LINE #	QTY	DESCRIPTION	REMARKS	UNIT PRICE	TOTAL
1	1.00	LOCATABLE MINERALS / MINING CLAIMS- NOT NEW-UNADJUD, ONE AUTH NO. ONLY / MINING CLAIM MONEY RECEIVED CASES: AMC368388/\$310.00		- n/a -	310.00
TOTAL:					\$310.00

PAYMENT INFORMATION			
NOTE: Items will appear on credit card statement as "BLM O Mining Claim".			
1	AMOUNT:	310.00	POSTMARKED: N/A
	TYPE:	CREDIT CARD	RECEIVED: 08/17/2017
	NAME:	GRAHAM C WILLIAMS 3325 MOUNT MCKINLEY DR SAN JOSE CA 95127 US	
	CARD NO:	XXXXXXXXXXXX3791	AUTH CODE: 01741Z
	NAME ON CARD:	GRAHAM C WILLIAMS	
	EXPIRES:	06/2018	
	SIGNATURE:		

REMARKS

This receipt was generated by the automated BLM Collections and Billing System and is a paper representation of a portion of the official electronic record contained therein.

Run Date: 07/20/17

Run Time: 10:48 AM

**DEPARTMENT OF THE INTERIOR
BUREAU OF LAND MANAGEMENT
MINING CLAIMS**

MC Maintenance Fees Paid Through the BLM Pay Portal

CBS Receipt: 3826170

Printed For Lead File # AMC368687

Agency Tracking ID: 1493667010

Assessment Year: 2018

Number of BLM Serial Nr: 1

Paid On: 05/01/2017

Total Amount Paid: \$155.00

Claim Name	BLM Serial No	Lead File No	Amount Paid
BLUE OWL	AMC368687	AMC368687	\$155.00

United States Department of the Interior
Bureau of Land Management
 BUSINESS & SUPPORT SVCS DIV
 ONE N CENTRAL AVE SUITE 800
 PHOENIX, AZ 85004 -4427
 Phone: 602-417-9200

Receipt

No: 3826170

Transaction #: 3934306	
Date of Transaction: 05/01/2017	
CUSTOMER:	
ZIMMERMANN 425 EAST GREENWAY DRIVE TEMPE, AZ 85282 US	

LINE #	QTY	DESCRIPTION	REMARKS	UNIT PRICE	TOTAL
1	1.00	LOCATABLE MINERALS / MINING CLAIMS- NOT NEW-UNADJUD, ONE AUTH NO. ONLY / MINING CLAIM MONEY RECEIVED CASES: AMC368687/\$155.00		- n/a -	155.00
TOTAL:					\$155.00

PAYMENT INFORMATION			
NOTE: Items will appear on credit card statement as "BLM O Mining Claim".			
1	AMOUNT:	155.00	POSTMARKED: N/A
	TYPE:	CREDIT CARD	RECEIVED: 05/01/2017
	NAME:	ZIMMERMANN 425 EAST GREENWAY DRIVE TEMPE AZ 85282 US	
	CARD NO:	XXXXXXXXXXXX0578	AUTH CODE: 069625
	NAME ON CARD:	ZIMMERMANN	
	EXPIRES:	10/2020	
	SIGNATURE:		

REMARKS

This receipt was generated by the automated BLM Collections and Billing System and is a paper representation of a portion of the official electronic record contained therein.

Run Date: 05/03/16

Run Time: 10:58 AM

**DEPARTMENT OF THE INTERIOR
BUREAU OF LAND MANAGEMENT
MINING CLAIMS**

MC Maintenance Fees Paid Through the BLM Pay Portal

CBS Receipt: 3538242

Printed For Lead File # **AMC368687**

Agency Tracking ID: 1460919461

Assessment Year: 2017

Number of BLM Serial Nr: 1

Paid On: 04/17/2016

Total Amount Paid: \$155.00

Claim Name	BLM Serial No	Lead File No	Amount Paid
BLUE OWL	AMC368687	AMC368687	\$155.00

United States Department of the Interior
Bureau of Land Management
 BUSINESS & SUPPORT SVCS DIV
 ONE N CENTRAL AVE SUITE 800
 PHOENIX, AZ 85004 -4427
 Phone: (602) 417-9200

Receipt

No: 3538242

Transaction #: 3640460	
Date of Transaction: 04/17/2016	
CUSTOMER:	
RICHARD E. ZIMMERMANN 425 E GREENWAY DRIVE TEMPE, AZ 85282 US	

LINE #	QTY	DESCRIPTION	REMARKS	UNIT PRICE	TOTAL
1	1.00	LOCATABLE MINERALS / MINING CLAIMS- NOT NEW-UNADJUD, ONE AUTH NO. ONLY / MINING CLAIM MONEY RECEIVED CASES: AMC368687/\$155.00		- n/a -	155.00
TOTAL:					\$155.00

PAYMENT INFORMATION			
NOTE: Items will appear on credit card statement as "BLM O Mining Claim".			
1	AMOUNT:	155.00	POSTMARKED: N/A
	TYPE:	CREDIT CARD	RECEIVED: 04/17/2016
	NAME:	RICHARD E. ZIMMERMANN 425 E GREENWAY DRIVE TEMPE AZ 85282 US	
	CARD NO:	XXXXXXXXXXXX0578	AUTH CODE: 011387
	NAME ON CARD:	RICHARD E. ZIMMERMANN	
	EXPIRES:	10/2020	
	SIGNATURE:		

REMARKS

This receipt was generated by the automated BLM Collections and Billing System and is a paper representation of a portion of the official electronic record contained therein.

Run Date: 06/22/15

Run Time: 01:11 PM

**DEPARTMENT OF THE INTERIOR
BUREAU OF LAND MANAGEMENT
MINING CLAIMS**

MC Maintenance Fees Paid Through the BLM Pay Portal

CBS Receipt: 3248313

Printed For Lead File # AMC368687

Agency Tracking ID: 1426097148

Assessment Year: 2016

Number of BLM Serial Nr: 1

Paid On: 03/11/2015

Total Amount Paid: \$155.00

Claim Name	BLM Serial No	Lead File No	Amount Paid
BLUE OWL	AMC368687	AMC368687	\$155.00



United States Department of the Interior

BUREAU OF LAND MANAGEMENT
Arizona State Office
One North Central Avenue, Suite 800
Phoenix, Arizona 85004-4427
www.blm.gov/az/



AMC 368687
AMC 350800

AMC 368687
350800

4099

IMPORTANT NOTICE

ADDITIONAL
PAYMENTS

ANNUAL MAINTENANCE FEES AND MINING CLAIM LOCATION FEES HAVE INCREASED

Effective June 30, 2014, the annual maintenance fee for mining claims increased from \$140 to \$155 per claim for lode mining claims, mill sites or tunnel sites; and from \$140 to \$155 for each 20 acres or portion thereof for each placer mining claim.

The increased maintenance fee will be required for the 2015 assessment year and is due on or before September 1, 2014.

If you have already paid your 2015 maintenance fee payment, you must send in the additional \$15 per claim, prior to September 1, 2014. (Placer mining claims over 20 acres must send in an additional \$15 per 20 acres or portion thereof.)

Also, the location fee for new mining claims has increased from \$34 to \$37. For new mining claims located on or after September 1, 2014, the cost will be \$212 per mining claim, plus \$155 per additional 20 acres or portion thereof for placer mining claims. This includes a \$37 location fee, \$155 maintenance fee and 20 processing fee.

All other mining claim fees will remain the same at this time.

*The fee adjustment is published in the Federal Register dated June 30, 2014. The text is accessible on the Federal Register website (www.federalregister.gov) and is available for public viewing at the Office of the Federal Register.

RECEIVED
BLM AZ STATE OFFICE
PHOENIX, ARIZONA
JUL 12 P 1:12

NEW!!! NOW AVAILABLE!!!
**PAY YOUR ANNUAL MINING CLAIM MAINTENANCE FEES
ON-LINE**

GO TO: www.blm.gov/payportal/home.html

For questions please contact our Public Room at 602-417-9200.

NO. OF CLAIMS 2
AMOUNT \$30.00
RECEIPT NO. 3099951
INIT. CLL

**** BLM-ASO****

United States Department of Interior
BUREAU OF LAND MANAGEMENT
Arizona State Office
One North Central Avenue, Suite 800
Phoenix, Arizona 85004-4427

PRESORTED
FIRST-CLASS MAIL
U.S. POSTAGE PAID
FREMONT, CA
PERMIT NO. 27



310 / 4 *****AUTO**3-DIGIT 852
ZECO INC, ZERAD LLC, ET AL.
425 E GREENWAY DR
TEMPE AZ 85282-6938

RECEIVED
BLM AZ STATE OFFICE
2014 AUG 12 P 1:12
PHOENIX, ARIZONA

United States Department of the Interior
Bureau of Land Management
 LANDS/RECREATION & PLANNING
 ONE N CENTRAL AVE
 PHOENIX, AZ 85004 -2203
 Phone: 602-417-9200

Receipt

No: 3099951

Transaction #: 3191491	
Date of Transaction: 08/13/2014	
CUSTOMER:	
ZECO INC 425 E GREENWAY DR TEMPE, AZ 85282-6938 US	

LINE #	QTY	DESCRIPTION	REMARKS	UNIT PRICE	TOTAL
1	1.00	LOCATABLE MINERALS / MINING CLAIMS-NOT NEW-UNADJUD, ONE AUTH NO. ONLY / MINING CLAIM MONEY RECEIVED CASES: AMC368687/\$30.00	ADD'L MAINT FEE PYMNT (2) 2015	- n/a -	30.00
TOTAL:					\$30.00

PAYMENT INFORMATION					
1	AMOUNT:	15.00	POSTMARKED:	08/11/2014	
	TYPE:	CHECK	RECEIVED:	08/12/2014	
	CHECK NO:	1062			
	NAME:	ZERAD LLC 425 E GREENWAY DR TEMPE AZ 85282-6938 US			
2	AMOUNT:	15.00	POSTMARKED:	08/11/2014	
	TYPE:	CHECK	RECEIVED:	08/12/2014	
	CHECK NO:	1524			
	NAME:	ZECO INC 425 E GREENWAY DR TEMPE AZ 85282-6938 US			

REMARKS

This receipt was generated by the automated BLM Collections and Billing System and is a paper representation of a portion of the official electronic record contained therein.

Amc 368687

MAINTENANCE FEE PAYMENT

Claimant Name: Zerad LLC
Address: 425 E. Greenway Dr.
City: Tempe State: AZ Zip: 85282
Telephone: 480 456 1010
E-mail address: reztempe@gmail.com
Signature: Richard J. Green

Check here if this is a change of address.

RECEIVED
BLM AZ STATE OFFICE
2014 APR 17 P 3:09
PHOENIX, ARIZONA
BLM,
Date
Stamp

LINE NO.	AMC NUMBER	CLAIM/SITE NAME	COUNTY RECORDER DATA (If available)	TWP	RNG	SEC
1	368687	Blue Owl				
2						
3						
4						
5						
6						
7						
8						
9						
10						

List additional claims on Form MCF114.

Bureau of Land Management
Arizona State Office
www.blm.gov/az/

No. of Claims: 1 x \$140 = 140.00
Check No: 10601 Init. CAH
Receipt No.: 3102776
For BLM Use Only

Form: MCF112
Revised July 2009

This form is available from the **Arizona Department of Mines and Mineral Resources** and may be reproduced.

ENTERED
APR 21 2014
BY: Rm

United States Department of the Interior
Bureau of Land Management
 LANDS/RECREATION & PLANNING
 ONE N CENTRAL AVE
 PHOENIX, AZ 85004 -2203
 Phone: 602-417-9200

Receipt

No: 3012934

Transaction #: 3102776	
Date of Transaction: 04/18/2014	
CUSTOMER:	
ZERAD INC 425 E GREENWAY DR TEMPE, AZ 85282-6938 US	

LINE #	QTY	DESCRIPTION	REMARKS	UNIT PRICE	TOTAL
1	1.00	LOCATABLE MINERALS / MINING CLAIMS- NOT NEW-UNADJUD, ONE AUTH NO. ONLY / MINING CLAIM MONEY RECEIVED CASES: AMC368687/\$140.00	MAINT FEE PYMNT (1) 2015	- n/a -	140.00
TOTAL:					\$140.00

PAYMENT INFORMATION					
1	AMOUNT:	140.00	POSTMARKED:	01/16/2014	
	TYPE:	CHECK	RECEIVED:	04/17/2014	
	CHECK NO:	1061			
	NAME:	ZERAD LLC 425 E GREENWAY DR TEMPE AZ 85282-6938 US			

REMARKS

This receipt was generated by the automated BLM Collections and Billing System and is a paper representation of a portion of the official electronic record contained therein.

ZIMMERMANN
425 E. Greenway Dr
Tempe, AZ 85282

RECEIVED
BLM AZ STATE OFFICE

2014 APR 17 P 3:02

PHOENIX, ARIZONA

PHOENIX, AZ 852

2014 APR 17 P 3:02



U.S. Dept. of Interior
Bureau of Land Management
Lands / Recreation & Planning
One N Central Ave
Phoenix, AZ 85004-2203

8500484414

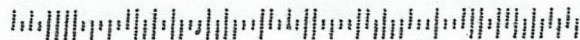

ENTERED INTO COMPUTER
APR 15 2013
PB

ANNUAL Fee - Mining Claim

ZERAD LLC
425 E GREENWAY
TEMPE, AZ 85282

91-601/1221 1039

DATE APR 5, 2013

PAY TO THE ORDER OF BLM

One hundred and forty ^{two}/₁₀₀ \$ 140.00 DOLLARS

Arizona Bank & Trust
7910 South Kyrene Road #108
Tempe, AZ 85284
(480) 346-4600
www.arizbank.com

MEMO AMC 368687

[Signature]

ZIMMERMAN
425 E. Greenway Dr.
Tempe, AZ 85282

PHOENIX AZ 852

09 APR 2013 PM 3:1

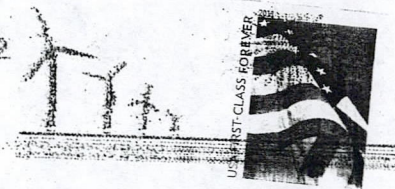

RECEIVED
BLM AZ STATE OFFICE
2013 APR 10 P 2:52

PHOENIX, ARIZ
US Dept. of Interior
BLM
Lands / Recreation + Planning
ONE N. Central Ave.
Phoenix, AZ 85004-2203

NO. OF CLAIMS
AMOUNT
RECEIPT NO.
INIT.
BLM-ASO

[Handwritten: 1, 140.00, 277244, [Signature]]

85004442700

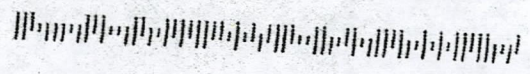

AMC 368687

ZIMMERMANN
425 E. Greenway Dr.
Tempe, AZ 85282

PHOENIX AZ 852

09 APR 2013 PM 3 1



RECEIVED
BLM AZ STATE OFFICE

2013 APR 10 P 2:52

PHOENIX, ARIZONA

US Dept. of Interior

BLM
Lands / Recreation + Planning

ONE N. Central Ave.

Phoenix, AZ 85004-2700

85004442700

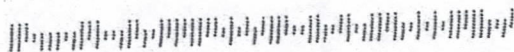

ZIMMERMAN

425 E. Greenway Dr.
Tempe, AZ 85282

RECEIVED
BLM AZ STATE OFFICE

2013 APR 10 P 2:52

PHOENIX, ARIZONA

US Dept. of Interior

BLM

Lands / Recreation + Planning

ONE N. Central Ave.

Phoenix, AZ 85004-2203

PHOENIX AZ 852

19 APR 2013 PM 3:11



85004442700

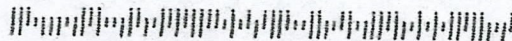

United States Department of the Interior
Bureau of Land Management
 LANDS/RECREATION & PLANNING
 ONE N CENTRAL AVE
 PHOENIX, AZ 85004 -2203
 Phone: 602-417-9200

Receipt

No: 2772440

Transaction #: 2856670		ENTERED INTO COMPUTER
Date of Transaction: 04/11/2013		
CUSTOMER:		APR 15 2013 <i>JB</i>
ZERAD INC 425 E GREENWAY DR TEMPE, AZ 85282-6938 US		

LINE #	QTY	DESCRIPTION	REMARKS	UNIT PRICE	TOTAL
1	1.00	LOCATABLE MINERALS / MINING CLAIMS- NOT NEW-UNADJUD, ONE AUTH NO. ONLY / MINING CLAIM MONEY RECEIVED CASES: AMC368687/\$140.00	MAINT FEE PYMNT (1) 2014	- n/a -	140.00
TOTAL:					\$140.00

PAYMENT INFORMATION					
1	AMOUNT:	140.00	POSTMARKED:	04/09/2013	
	TYPE:	CHECK	RECEIVED:	04/10/2013	
	CHECK NO:	1039			
	NAME:	ZERAD LLC 425 E GREENWAY DR TEMPE AZ 85282-6938 US			

REMARKS	

This receipt was generated by the automated BLM Collections and Billing System and is a paper representation of a portion of the official electronic record contained therein.

U.S. DEPARTMENT OF THE INTERIOR
BUREAU OF LAND MANAGEMENT



Mining Claims

Last modified: 04/15/2013 11:15:31 Status: ACTIVE

Serial Number

AMC368687

- [View](#) [Void](#) [Delete](#) [Copy](#)

[Serial Register Page](#)

Case Header Details

Case Type	Claim Name	Commodity	Lead File Nr	Case Acres	Curr Mnt Fee
384101	BLUE OWL		AMC368687	20.660	\$140.00

[Update Header Details](#)

Owner Details

Search Criteria: Search Column: [Search](#)

Proprietor Name(LFI)	Int Rel	Address	Address2	C
ZERAD LLC	58	425 E GREENWAY DR		TEMPE
ZIMMERMANN RICHARD E	58	425 E GREENWAY DR		TEMPE

[Update Customer Details](#) # Customers: 2 [Update Multiple Cases](#)

Land Description Details

Meridian: Township: Range: Section: Search Column: [Search](#)

Meridian	Twp	Range	Sec	NE	NW	SW	SE	Geo St	County	Office	SMA
14	0080N	0040W	023		X	X		AZ	YAVAPAI	HASSAYAMPA FO	BUREAU OF LAND MGMT

[Update Location Details](#) # Locations: [Update Multiple Cases](#)

Action Details

Search Criteria: Search Column: [Search](#)

	Date (mm/dd/yyyy)	Code	Action Taken	Action Remarks	Receipt Nr
1	12/03/2005	403	LOCATION DATE		
2	12/12/2005	395	RECORDATION NOTICE RECD	1	1202104
3	04/10/2013	682	MAINTENANCE FEE/\$140	2014;\$140	2772440
4	04/10/2013	392	MONIES RECEIVED	\$140.00;1	2772440
5	03/19/2012	682	MAINTENANCE FEE/\$140	2013;\$140	2535581
6	04/07/2011	682	MAINTENANCE FEE/\$140	2012	2323261
7	11/23/2010	396	TRF OF INTEREST FILED	ZERAD INC	2251052

[Update Action Details](#) # Actions: 16 [Update Multiple Cases](#)

Remarks

Search Criteria: Search Column: [Search](#)

Line #	Remarks
---	No Data Found

[Update Remarks](#) # Remarks: 0 [Update Multiple Cases](#)

Top of Screen

U.S. DEPARTMENT OF THE INTERIOR **BUREAU OF LAND MANAGEMENT**
California

AMC 368687

MINING CLAIM MAINTENANCE FEE PAYMENT FORM

USDI Bureau of Land Management, 2800 Cottage Way, Room W1623, Sacramento, CA 95825

The Mining Claim Maintenance Fees of \$140 per claim or site may be paid by cash, check, money order, or credit card (VISA, American Express, Discover, or MasterCard). Payments should be mailed to the Bureau of Land Management at the address above. Allow sufficient mailing time so that your payment will be received in our office by the due date of September 1st. If you wish to pay by telephone using your credit card, please call BLM at (916) 978-4400. If paying by phone, please have all information that will be requested in order before you place your call.

CLAIMANT NAME: Zerad, LLC

ADDRESS: 425 E Greenway Drive
Tempe, AZ 85282 6938

Claim Name(s)	CAMC Numbers
BLUE OWL	AMC 368687
ENTERED INTO COMPUTER	
MAR 23 2012 PB	
	2012 MAR 19 PM 2:14
	PHOENIX, ARIZONA
	BLM AZ STATE OFFICE
	RECEIVED

-----Additional claims & CAMC numbers can be listed on a separate page.-----

IF USING A CREDIT CARD, COMPLETE THE FOLLOWING:

Number of Claims _____ X \$140 = \$ _____ as maintenance fee payment for year 2012

EXACT NAME

ON CREDIT CARD: _____

Amount Paid: \$ 140 Circle one: VISA * AMERICAN EXP. * MASTERCARD * DISCOVER

CREDIT CARD NUMBER: _____

Expiration Date: _____ Telephone: (480) 456 1710

Signature: Richard J. Sumner

Title 18 USC Section 1001, makes it a crime for any person knowingly and willfully providing any department or agency of the United States any false, fictitious or fraudulent statement or representation as to any matter within its jurisdiction.

To mining claim filing instructions

NO. OF CLAIMS 1
AMOUNT \$140.00
RECEIPT NO. 2535581
INIT. CLH

** BLM-ASO**

ZIMMERMAN
425 E Greenway Dr.
Tempe AZ 85282

PHOENIX AZ 852

16 MAR 2012 PM 4 L



RECEIVED
BLM AZ STATE OFFICE

PHOENIX, ARIZONA

2012 MAR 19 PM 5:13

US Dept of Interior
Bureau of Land Management
Business & Support Services Div
ONE N. Central Ave Suite 8
Phoenix AZ 85004-4427

8500484427

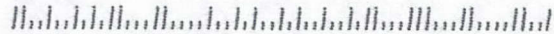

ZIMMERMAN
425 E Greenway Dr.
Tempe AZ 85282

PHOENIX AZ 852

16 MAR 2012 PM 4 L



PHOENIX, ARIZONA

2012 MAR 19 PM 2:16

RECEIVED
LM AZ STATE OFFICE

US Dept of Interior
Bureau of Land Management
Business + Support Services Div
ONE N. Central Ave Suite 800
Phoenix AZ 85004-4427

8500484427

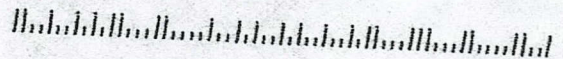

United States Department of the Interior
Bureau of Land Management
 LANDS/RECREATION & PLANNING
 ONE N CENTRAL AVE
 PHOENIX, AZ 85004 -2203
 Phone: 602-417-9200

Receipt

No: 2535581

Transaction #: 2614061	ENTERED INTO COMPUTER
Date of Transaction: 03/20/2012	
CUSTOMER:	MAR 23 2012 JB
ZERAD INC 425 E GREENWAY DR TEMPE, AZ 85282-6938 US	

LINE #	QTY	DESCRIPTION	REMARKS	UNIT PRICE	TOTAL
1	1.00	LOCATABLE MINERALS / MINING CLAIMS-NOT NEW-UNADJUD, ONE AUTH NO. ONLY / MINING CLAIM MONEY RECEIVED CASES: AMC368687/\$140.00	MAINT FEE PYMNT (1) 2013	- n/a -	140.00
TOTAL:					\$140.00

PAYMENT INFORMATION					
1	AMOUNT:	140.00	POSTMARKED:	03/16/2012	
	TYPE:	CHECK	RECEIVED:	03/20/2012	
	CHECK NO:	1037			
	NAME:	ZERAD LLC 425 E GREENWAY DR TEMPE AZ 85282-6938 US			

REMARKS

This receipt was generated by the automated BLM Collections and Billing System and is a paper representation of a portion of the official electronic record contained therein.

Amc 368687

MAINTENANCE FEE PAYMENT

Claimant Name: Zerad LLC
Address: 425 E Greenway Dr.
City: Tempe State: AZ Zip: 85282
Telephone: 480 456 1010
E-mail address: me@zerad.com
Signature: [Handwritten Signature]

RECEIVED
BLM ARIZONA STATE OFFICE
2011 APR - 7 A 9:34
PHOENIX, ARIZONA
BLM Date Stamp

Check here if this is a change of address.

LINE NO.	AMC NUMBER	CLAIM/SITE NAME	COUNTY RECORDER DATA (If available)	TWP	RNG	SEC
1	368687	Blue Owl		8N	4W	23
2						
3						
4						
5						
6						
7						
8						
9						
10						

List additional claims on Form MCF114.

Bureau of Land Management
Arizona State Office
www.blm.gov/az/

No. of Claims: 1 x \$140 = 140.00
Check No: [Handwritten] Init. [Handwritten]
Receipt No.: [Handwritten]
For BLM Use Only

Form: MCF112
Revised July 2009

This form is available from the Arizona Department of Mines and Mineral Resources and may be reproduced.

ENTERED INTO COMPUTER
APR 11 2011 [Handwritten]

United States Department of the Interior
 Bureau of Land Management
 LANDS/RECREATION & PLANNING
 ONE N CENTRAL AVE
 PHOENIX, AZ 85004 -2203
 Phone:

Receipt

No:

2323261

Transaction #: 2396880		ENTERED INTO COMPUTER
Date of Transaction: 04/08/2011		
CUSTOMER: APR 11 2011 <i>DB</i>		
ZERAD INC 425 E GREENWAY DR TEMPE, AZ 85282-6938 US		

LINE #	QTY	DESCRIPTION	REMARKS	UNIT PRICE	TOTAL
1	1.00	LOCATABLE MINERALS / MINING CLAIMS-NOT NEW-UNADJUD, ONE AUTH NO. ONLY / MINING CLAIM MONEY RECEIVED CASES: AMC368687/\$140.00	MAINT-140	- n/a -	140.00
TOTAL:					\$140.00

PAYMENT INFORMATION					
1	AMOUNT:	140.00	POSTMARKED:	04/04/2011	
	TYPE:	CHECK	RECEIVED:	04/07/2011	
	CHECK NO:	1002			
	NAME:	ZERAD LLC 425 E GREENWAY DR TEMPE AZ 85282-6938 US			

REMARKS

This receipt was generated by the automated BLM Collections and Billing System and is a paper representation of a portion of the official electronic record contained therein.

ZIMMERMANN
425 E. Greenway Dr
Tempe AZ 85282

PHOENIX AZ 850

04 APR 11 PM 10 T



RECEIVED
BLM AZ STATE OFFICE

2011 APR -5 P 2:59

PHOENIX, ARIZONA

Bureau of Land Management
Arizona State Office
One North Central Ave.
Suite 800

Phoenix, AZ 85004 - 4427

85004+4427

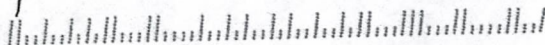

**DEPARTMENT OF THE INTERIOR
BUREAU OF LAND MANAGEMENT
MINING CLAIMS**

Run Date/Time: 04/24/2010 09:33 AM

(LIVE) Serial Register Page

Page 1 of

01 05-10-1872;017STAT0091;30USC26,28,34

Case Type 384101: LODE CLAIM

Claim Name: BLUE OWL

Commodity :

Case Disposition: ACTIVE

Serial Number

AMC368687

Lead File Number

AMC368687

Name & Address				Int Rel	% Interest
ZIMMERMANN RICHARD E	425 E GREENWAY DR	TEMPE, AZ 85282		CLAIMANT	0.000000C
ZERAD INC	425 E GREENWAY DR	TEMPE, AZ 85282		CLAIMANT	0.000000C

Mer Twp	Rng	Sec	Quadrant	District/Resource	County
14	0080N	0040W	023	NW SW	HASSAYAMPA FIELD OFFICE
					YAVAPAI

Act Date	Code	Action	Action Remarks	Receipt Number
12/03/2005	403	LOCATION DATE		
12/12/2005	395	RECORDATION NOTICE RECD	1	1202104
04/23/2010	682	MAINTENANCE FEE/\$140	2011	2123183
04/21/2009	582	MAINTENANCE FEE/\$125	2010	1908789
06/20/2008	582	MAINTENANCE FEE/\$125	2009	1728555
05/16/2007	582	MAINTENANCE FEE/\$125	2008	1492365
04/20/2006	582	MAINTENANCE FEE/\$125	2007	1269563
12/15/2005	484	LOCATION YEAR / MAINTENANCE	2006	1202104
04/23/2010	392	MONIES RECEIVED	\$140.00;1	2123183
08/05/2009	399	CURABLE \$15 MAINT FEE	2010	1972345
03/16/2006	669	LAND STATUS CHECKED		
12/12/2005	501	ACCT ADV IN LEAD FILE	AMC368687;	

Line Nr Remarks

United States Department of the Interior
Bureau of Land Management
 LANDS/RECREATION & PLANNING
 ONE N CENTRAL AVE
 PHOENIX, AZ 85004 -2203
 Phone:

Receipt

No: 2123183

Transaction #: 2191476		ENTERED INTO COMPUTER
Date of Transaction: 04/23/2010		
CUSTOMER:	ZERAD INC 425 E GREENWAY DR TEMPE, AZ 85282-6938 US	APR 24 2010 <i>PR</i>

LINE #	QTY	DESCRIPTION	REMARKS	UNIT PRICE	TOTAL
1	2.00	LOCATABLE MINERALS / MINING CLAIMS- NOT NEW-UNADJUD, ONE AUTH NO. ONLY / MINING CLAIM MONEY RECEIVED CASES: AMC350800/\$140.00, AMC368687/ \$140.00	2 MAINT FEE 2011	- n/a -	280.00
TOTAL:					\$280.00

PAYMENT INFORMATION					
1	AMOUNT:	140.00	POSTMARKED:	04/21/2010	
	TYPE:	CHECK	RECEIVED:	04/23/2010	
	CHECK NO:	198			
	NAME:	ZERAD INC 425 E GREENWAY DR TEMPE AZ 85282-6938 US			
2	AMOUNT:	140.00	POSTMARKED:	04/21/2010	
	TYPE:	CHECK	RECEIVED:	04/23/2010	
	CHECK NO:	2312			
	NAME:	ZECO INC 425 E GREENWAY DR TEMPE AZ 85282-6938 US			

REMARKS
MAINT FEE PAYMENT FORM WAS NOT ENCLOSED WITH PAYMENT.

This receipt was generated by the automated BLM Collections and Billing System and is a paper representation of a portion of the official electronic record contained therein.

United States Department of the Interior
 Bureau of Land Management
 BUSINESS & SUPPORT SVCS DIV
 ONE N CENTRAL AVE SUITE 800
 PHOENIX, AZ 85004 -4427
 Phone: (602) 417-9200

AMC 350800
 368687

Receipt

No: 1972345

Transaction #: 2036230	
Date of Transaction: 08/06/2009	
CUSTOMER:	ZECO INC 425 E GREENWAY DR TEMPE, AZ 85282-6938 US

LINE #	QTY	DESCRIPTION	REMARKS	UNIT PRICE	TOTAL
1	1.00	LOCATABLE MINERALS / MINING CLAIMS-NOT NEW-UNADJUD, ONE AUTH NO. ONLY / MINING CLAIM MONEY RECEIVED CASES: AMC350800/\$30.00	MAINT (2)	- n/a -	30.00
TOTAL:					\$30.00

PAYMENT INFORMATION			
1	AMOUNT:	15.00	POSTMARKED: 08/03/2009
	TYPE:	CHECK	RECEIVED: 08/05/2009
	CHECK NO:	193	
	NAME:	ZERAD INC 425 E GREENWAY DR TEMPE AZ 85282-6938 US	
2	AMOUNT:	15.00	POSTMARKED: 08/03/2009
	TYPE:	CHECK	RECEIVED: 08/05/2009
	CHECK NO:	2177	
	NAME:	ZECO INC 425 E GREENWAY DR TEMPE AZ 85282-6938 US	

REMARKS

This receipt was generated by the automated BLM Collections and Billing System and is a paper representation of a portion of the official electronic record contained therein.

368687





United States Department of the Interior

BUREAU OF LAND MANAGEMENT
Arizona State Office
One North Central Avenue, Suite 800
Phoenix, Arizona 85004-4427
www.blm.gov/az



IMPORTANT NOTICE

ANNUAL MAINTENANCE FEE AND MINING CLAIM LOCATION FEE HAVE INCREASED

RECEIVED
BLM AZ STATE OFFICE
2009 AUG - 5 A 8: 17
PHOENIX, ARIZONA

The annual maintenance fee for mining claims has increased from \$125 to \$140 per claim. The maintenance fee for the 2010 assessment year is due to BLM on or before September 1, 2009. If you have already paid your 2010 maintenance fee payment, you must send in the additional \$15 per claim prior to September 1, 2009.

Also, the location fee for new mining claims has increased from \$30 to \$34. Any new mining claims located on or after September 1, 2009, will cost \$189 per claim. This includes a \$34 location fee, \$140 maintenance fee, and \$15 processing fee.

This change in mining claim fees is in accordance with 30 U.S.C. 28j(c), which authorizes adjustments to the location and annual maintenance fees "to reflect changes in the Consumer Price Index published by the Bureau of Labor Statistics of the Department of Labor every 5 years after August 10, 1993, or more frequently if the Secretary determines an adjustment to be reasonable." The BLM has not adjusted the location and maintenance fees since 2004.

The fee adjustment is published in the Federal Register dated June 29, 2009. Copies of the rule are available from BLM State Offices and its Washington, D.C., Office. The text is also accessible on the Federal Register Web site (www.access.gpo.gov) and is available for public viewing at the Office of the Federal Register.

For questions please contact Tony Smith at 602-417-9355 or Rod Ebert at 602-417-9397.

United States Department of Interior
BUREAU OF LAND MANAGEMENT
Arizona State Office
One North Central Avenue, Suite 800
Phoenix, Arizona 85004-4427

PRSR STD
U.S. Postage
PAID
Phoenix, AZ
Permit 1010



*****3-DIGIT 852
ZIMMERMANN RICHARD E
425 E GREENWAY DR
TEMPE AZ 85282-6938

0000934

AMC 368687

BLUE
OWL

ZERAD INC.
425 E GREENWAY DR.
TEMPE, AZ 85282

191

DATE APR 16 2009

PAY TO THE
ORDER OF

BLM

One hundred and Twenty Five ⁰⁰/₁₀₀ \$125.00
DOLLARS

M&I Marshall & Ilsley Bank
ARIZONA

MEMO

AMC 368687

Richard J. Miller MP
480 456 1010

ENTERED INTO COMPUTER
5/12/09 DJJ

United States Department of the Interior
Bureau of Land Management
 BUSINESS & SUPPORT SVCS DIV
 ONE N CENTRAL AVE SUITE 800
 PHOENIX, AZ 85004 -4427
 Phone: (602) 417-9200

Receipt

No:

1908789

Transaction #: 1971246	
Date of Transaction: 04/22/2009	
CUSTOMER:	ZERAD INC 425 E GREENWAY DR TEMPE, AZ 85282-6938 US

LINE #	QTY	DESCRIPTION	REMARKS	UNIT PRICE	TOTAL
1	1.00	LOCATABLE MINERALS / MINING CLAIMS-NOT NEW-UNADJUD, ONE AUTH NO. ONLY / MINING CLAIM MONEY RECEIVED CASES: AMC368687/\$125.00	MAINT 2009/1	- n/a -	125.00
TOTAL:					\$125.00

PAYMENT INFORMATION			
1	AMOUNT:	125.00	POSTMARKED: 04/17/2009
	TYPE:	CHECK	RECEIVED: 04/21/2009
	CHECK NO:	191	
	NAME:	ZERAD INC. 425 E GREENWAY DR TEMPE AZ 85282-6938 US	

REMARKS
<i>480.456.1010</i>

This receipt was generated by the automated BLM Collections and Billing System and is a paper representation of a portion of the official electronic record contained therein.

AMC 368687

ZERAD INC.
425 East Greenway Drive
Tempe, AZ 85282-6938

To: BLM
One. N. Central Ave
Phoenix, AZ 85004-4427

From: Dick Zimmermann

Subject: Fee for AMC 368687 (AZA33385, Blue Owl Claim)

A check for the annual maintenance fee is enclosed.

ENTERED INTO COMPUTER
JUL 07 2008 PB

RECEIVED
BLM, AZ STATE OFFICE
2008 JUN 20 A 7:21
PHOENIX, ARIZONA

P
AMC
\$135
1728555

United States Department of the Interior
 Bureau of Land Management
 BUSINESS & SUPPORT SVCS DIV
 ONE N CENTRAL AVE SUITE 800
 PHOENIX, AZ 85004 -4427
 Phone: (602) 417-9200

Receipt

No:

1728555

Transaction #: 1785337		ENTERED INTO COMPUTER JUL 07 2008 PB
Date of Transaction: 06/20/2008		
CUSTOMER:	ZERAD INC 425 E GREENWAY DR TEMPE, AZ 85282	

LINE #	QTY	DESCRIPTION	REMARKS	UNIT PRICE	TOTAL
1	1.00	LOCATABLE MINERALS / MINING CLAIMS-NOT NEW-UNADJUD, ONE AUTH NO. ONLY / MINING CLAIM MONEY RECEIVED (455) CASES: AMC368687/\$125.00	MAINT 2009/1	- n/a -	125.00
TOTAL:					\$125.00

PAYMENT INFORMATION					
1	AMOUNT:	\$125.00	POSTMARKED:	6/18/08 0:00	
	TYPE:	CHECK	RECEIVED:	06/20/2008	
	CHECK NO:	187			
	NAME:	ZERAD INC. 425 E GREENWAY DR TEMPE AZ 85282			

REMARKS

This receipt was generated by the automated BLM Collections and Billing System and is a paper representation of a portion of the official electronic record contained therein.

AMC 368687

Zerad, Inc.
425 East Greenway Drive
Tempe, AZ 85282-6938
May 14, 2007

To: BLM

From: Dick Zimmermann

Subject: Fee for AMC368687

A check for the annual maintenance fee is enclosed.

ENTERED INTO COMPUTER
MAY 23 2007 SS

RECEIVED
B.L.M. AZ STATE OFFICE
2007 MAY 16 A 10:36
PHOENIX, ARIZONA

United States Department of the Interior
 Bureau of Land Management
 BUSINESS & SUPPORT SVCS DIV
 ONE N CENTRAL AVE SUITE 800
 PHOENIX, AZ 85004 -4427
 Phone: (602) 417-9200

Receipt

No: 1492365

Transaction #: 1542355		ENTERED INTO COMPUTER
Date of Transaction: 05/17/2007		
CUSTOMER:	ZERAD INC 425 E GREENWAY DR TEMPE, AZ 85282	MAY 23 2007 VERIFIED MAY 24 2007

LINE #	QTY	DESCRIPTION	REMARKS	UNIT PRICE	TOTAL
1	1.00	LOCATABLE MINERALS / MINING CLAIMS-NOT NEW-UNADJUD, ONE AUTH NO. ONLY / MINING CLAIM MONEY RECEIVED (455) CASES: AMC368687/\$125.00	MAIN 2008 (1)	- n/a -	125.00
TOTAL:					\$125.00

PAYMENT INFORMATION					
1	AMOUNT:	\$125.00	POSTMARKED:	5/14/07 0:00	
	TYPE:	CHECK	RECEIVED:	05/16/2007	
	CHECK NO:	182			
	NAME:	ZERAD INC 425 E GREENWAY DR TEMPE AZ 85282			

REMARKS

This receipt was generated by the automated BLM Collections and Billing System and is a paper representation of a portion of the official electronic record contained therein.

B. Thomas O'May
P.O. Box 19638
Paradise, NV 89132-0638
U.S.A.

12/08/06

TO: BLM - AZ STATE OFFICE

ENCLOSED (2 COPIES OF EACH OF
2 DOCUMENTS)

NOTICE OF INTENTION TO HOLD
MINING CLAIMS (APRZ)

RINCON GOLD #12 AMC369651

RINCON GOLD #16 AMC369890

NOTICE OF INTENTION TO
MINING CLAIM (MARICOPA)

CANYON GOLD #8 AMC369690

PERSONAL CHECK IN SUM OF \$30.

SELF-ADDRESSED STAMPED ENVELOPE

THANK YOU, Dr. B. Thomas O'May
TEL: 1-762-610-7840
GOLD MINER @ GOLD ORE STORE LTD. CO
Merry Christmas & Happy New Year

AMC 369687

Amc 369890
 Amc 369629
 Amc 369687

NOTICE OF INTENTION TO HOLD MINING CLAIMS/SITES

When Recorded Return Document to:

B. Thomas O'Man

P.O. Box 19638

Paradise, NV 89132-0638

BLM
 Date
 Stamp

PHOENIX, ARIZONA

2006 DEC 13 A 11:09

RECEIVED
 B.L.M. AZ STATE OFFICE

Check here if this is a change of address.

Telephone: 1-702-610-7840

E-mail Address GoldMiner@GoldOreStoreLtd.com

I (We) intend to hold the claims(s) and/or site(s) listed below for the calendar year 2006, and I (We) have filed or will file a Notice of Intent to Hold in the county where the claim (s) is located.

Reason for filing a Notice of Intent to Hold instead of an assessment work filing (check one):

- Maintenance fee was paid to maintain claim(s) during this assessment year.
- Mill or tunnel sites.
- Claim(s) was located during the current assessment year.
- BLM has deferred assessment work (attach copy of decision granting deferment, or pending petition for deferment including date petition was filed.)

Line No.	AMC NUMBER	CLAIM/SITE NAME	COUNTY RECORDER DATA (If available)	TWP	RNG	SEC	
1	369631	Rincon Gold #12		7N	12W	30	(NE4)
2	369890	Rincon Gold #16		7N	12W	30	(SE4)
3							
4							
5							
6							
7							
8							
9							
10							

RE 1/18/07

NOTICE OF INTENTION TO HOLD MINING CLAIMS/SITES
page 2

BLM
Date
Stamp

2006 DEC 13 A 11:09
PHOENIX, ARIZONA

RECEIVED
B.L.M. AZ STATE OFFICE

1. State of Nevada County of Clark

2. I (Name) B. Thomas O'Man

3. Reside at (Address) P.O. Box 19638

City Paradise County Clark State NV Zip 89132-0638

being duly sworn, depose and say that I am a citizen of the United States, more than eighteen years of age, that all of the facts set forth in this notice, subject to the provisions and penalties of 18 U.S.C. 1001 pertaining to the filing of false, fictitious, or fraudulent statements with the United States, are true and correct according to the best of my knowledge, information and belief.

4. Owner's name and address (if not shown in Items 1-3 above) _____

5. Dated: 12/08/06 Signature: B. Thomas O'Man

Bureau of Land Management
Arizona State Office
www.az.blm.gov

No. of Claims: 2 x \$10 = 20
Check No: 823 Init. SB8
Receipt No.: 1409988
For BLM Use Only

SUBSCRIBED AND SWORN TO before me, a Notary Public, this 8th day of December 2006

By: _____
Notary Public [Signature]

MY COMMISSION EXPIRES 10-11-10

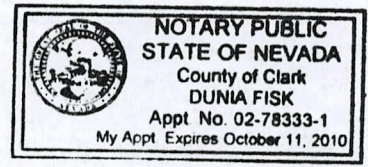

Form: MCF110
Revised Jan. 2006
Page 2 of 2

NOTICE OF INTENTION TO HOLD MINING CLAIMS/SITES

When Recorded Return Document to:

B. Thomas O'Man

P.O. Box 19638

Paradise, NV 89132-0638

BLM
Date
Stamp

PHOENIX, ARIZONA

2006 DEC 13 A 11:08

RECEIVED
B.L.M. AZ STATE OFFICE

Check here if this is a change of address.

Telephone: 1-702-610-7840

E-mail Address GoldMiner@GoldOreStoreLtd.com

I (We) intend to hold the claims(s) and/or site(s) listed below for the calendar year 2006, and I (We) have filed or will file a Notice of Intent to Hold in the county where the claim (s) is located.

Reason for filing a Notice of Intent to Hold instead of an assessment work filing (check one):

- Maintenance fee was paid to maintain claim(s) during this assessment year.
- Mill or tunnel sites.
- Claim(s) was located during the current assessment year.
- BLM has deferred assessment work (attach copy of decision granting deferment, or pending petition for deferment including date petition was filed.)

Line No.	AMC NUMBER	CLAIM/SITE NAME	COUNTY RECORDER DATA (if available)	TWP	RNG	SEC
1	369690	Canyon Gold #8		6N	10W	12
2						
3						
4						
5						
6						
7						
8						
9						
10						

(SE4)

NOTICE OF INTENTION TO HOLD MINING CLAIMS/SITES
page 2

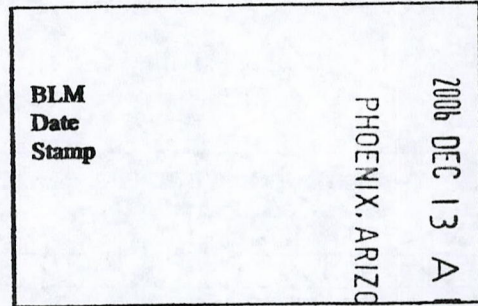

RECEIVED
BLM, AZ STATE OFFICE

1. State of Nevada County of Clark

2. I (Name) B. Thomas O'Man

3. Reside at (Address) P.O. Box 19638

City Paradise County Clark State NV Zip 89132-0638

being duly sworn, depose and say that I am a citizen of the United States, more than eighteen years of age, that all of the facts set forth in this notice, subject to the provisions and penalties of 18 U.S.C. 1001 pertaining to the filing of false, fictitious, or fraudulent statements with the United States, are true and correct according to the best of my knowledge, information and belief.

4. Owner's name and address (if not shown in items 1-3 above). _____

5. Dated: 12/08/06 Signature: B. Thomas O'Man

Bureau of Land Management
Arizona State Office
www.az.blm.gov

No. of Claims:	<u>1</u>	x \$10 =	<u>10</u>
Check No:	<u>823</u>	Init.	<u>SB8</u>
Receipt No.:	<u>1409988</u>		
For BLM Use Only			

SUBSCRIBED AND SWORN TO before me, a Notary Public, this 8th day of December 2006

By: _____

Notary Public D. Fisk

MY COMMISSION EXPIRES 10-11-10

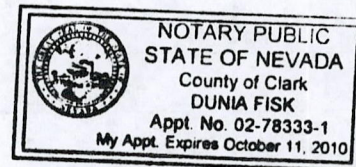

Form: MCF110
Revised Jan. 2006
Page 2 of 2

NOTICE OF INTENTION TO HOLD MINING CLAIMS/SITES

When Recorded Return Document to:

B. Thomas O'Man
P.O. Box 19638
Paradise, NV 89132-0638

BLM
Date
Stamp

Check here if this is a change of address.
 Telephone: 1-702-610-7840
 E-mail Address GoldMiner@GoldOreStoreLtd.com

I (We) intend to hold the claims(s) and/or site(s) listed below for the calendar year 2006, and I (We) have filed or will file a Notice of Intent to Hold in the county where the claim (s) is located.

Reason for filing a Notice of Intent to Hold instead of an assessment work filing (check one):

- Maintenance fee was paid to maintain claim(s) during this assessment year.
- Mill or tunnel sites.
- Claim(s) was located during the current assessment year.
- BLM has deferred assessment work (attach copy of decision granting deferment, or pending petition for deferment including date petition was filed.)

Line No.	AMC NUMBER	CLAIM/SITE NAME	COUNTY RECORDER DATA (If available)	TWP	RNG	SEC	
1	369631	Rincon Gold #12		7N	12W	30	(NE4)
2	369890	Rincon Gold #16		7N	12W	30	(SE4)
3							
4							
5							
6							
7							
8							
9							
10							

NOTICE OF INTENTION TO HOLD MINING CLAIMS/SITES
page 2

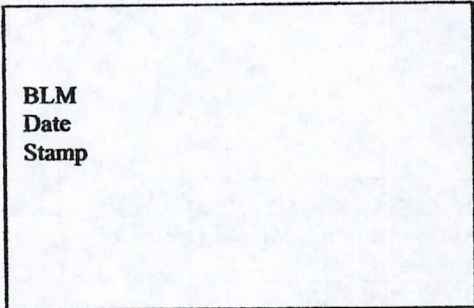

1. State of Nevada County of Clark
2. I (Name) B. Thomas O'Man
3. Reside at (Address) P.O. Box 19638

City Paradise County Clark State NV Zip 89132-0638 being duly sworn, depose and say that I am a citizen of the United States, more than eighteen years of age, that all of the facts set forth in this notice, subject to the provisions and penalties of 18 U.S.C. 1001 pertaining to the filing of false, fictitious, or fraudulent statements with the United States, are true and correct according to the best of my knowledge, information and belief.

4. Owner's name and address (If not shown in Items 1-3 above). _____

5. Dated: 12/08/06 Signature: B. Thomas O'Man

Bureau of Land Management
Arizona State Office
www.az.blm.gov

No. of Claims: 2 x \$10 = 20
Check No: 823 Init. SB
Receipt No.: 1409988
For BLM Use Only

SUBSCRIBED AND SWORN TO before me, a Notary Public, this 8th day of December 20 06

By: _____
Notary Public [Signature]

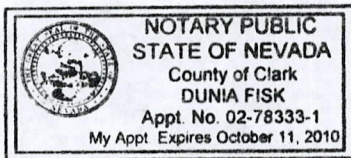

MY COMMISSION EXPIRES 10-11-10

NOTICE OF INTENTION TO HOLD MINING CLAIMS/SITES

When Recorded Return Document to:

B. Thomas O'Man
P.O. Box 19638
Paradise, NV 89132-0638

BLM
Date
Stamp

Check here if this is a change of address.
 Telephone: 1-702-610-7840

E-mail Address GoldMiner@GoldOreStoreLtd.com

I (We) intend to hold the claims(s) and/or site(s) listed below for the calendar year 2006, and I (We) have filed or will file a Notice of Intent to Hold in the county where the claim (s) is located.

Reason for filing a Notice of Intent to Hold instead of an assessment work filing (check one):

- Maintenance fee was paid to maintain claim(s) during this assessment year.
- Mill or tunnel sites.
- Claim(s) was located during the current assessment year.
- BLM has deferred assessment work (attach copy of decision granting deferment, or pending petition for deferment including date petition was filed.)

Line No.	AMC NUMBER	CLAIM/SITE NAME	COUNTY RECORDER DATA (If available)	TWP	RNG	SEC
1	369690	Canyon Gold #8		6N	10W	12
2						
3						
4						
5						
6						
7						
8						
9						
10						

(SE4)

NOTICE OF INTENTION TO HOLD MINING CLAIMS/SITES
page 2

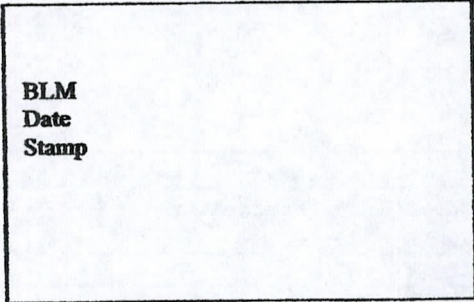

1. State of Nevada County of Clark

2. I (Name) B. Thomas O'Man

3. Reside at (Address) P.O. Box 19638

City Paradise County Clark State NV Zip 89132-0638

being duly sworn, depose and say that I am a citizen of the United States, more than eighteen years of age, that all of the facts set forth in this notice, subject to the provisions and penalties of 18 U.S.C. 1001 pertaining to the filing of false, fictitious, or fraudulent statements with the United States, are true and correct according to the best of my knowledge, information and belief.

4. Owner's name and address (if not shown in Items 1-3 above) _____

5. Dated: 12/08/06 Signature: B. Thomas O'Man

Bureau of Land Management
Arizona State Office
www.az.blm.gov

No. of Claims:	<u>1</u>	x \$10 =	<u>10</u>
Check No:	<u>823</u>	Init.	<u>SB8</u>
Receipt No.:	<u>1409988</u>		
For BLM Use Only			

SUBSCRIBED AND SWORN TO before me, a Notary Public, this 8th day of December 20 06

By: _____
Notary Public D. Fisk

MY COMMISSION EXPIRES 10-11-10

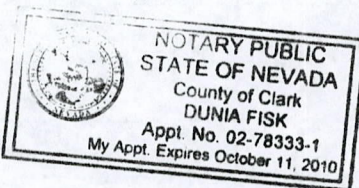

Form: MCF110
Revised Jan. 2006
Page 2 of 2

United States Department of the Interior
 Bureau of Land Management
 BUSINESS & SUPPORT SVCS DIV
 ONE N CENTRAL AVE SUITE 800
 PHOENIX, AZ 85004 -4427
 Phone: (602) 417-9200

Receipt

No: 1409988

Transaction #: 1456730	
Date of Transaction: 12/15/2006	
CUSTOMER:	THOMAS O'MAN PO BOX 19638 PARADISE,NV 89132

LINE #	QTY	DESCRIPTION	REMARKS	UNIT PRICE	TOTAL
1	1.00	LOCATABLE MINERALS / MINING CLAIMS-NOT NEW-UNADJUD,ONE AUTH NO. ONLY / MINING CLAIM MONEY RECEIVED (455) CASES: AMC369631/\$30.00	NOI (3)	- n/a -	30.00
TOTAL:					\$30.00

PAYMENT INFORMATION					
1	AMOUNT:	\$30.00	POSTMARKED:	12/08/2006	
	TYPE:	CHECK	RECEIVED:	12/13/2006	
	CHECK NO:	823			
	NAME:	O'MAN, B T PO BOX 19638 PARADISE NV 89132			

REMARKS

This receipt was generated by the automated BLM Collections and Billing System and is a paper representation of a portion of the official electronic record contained therein.

Amc 368687

ZERAD INC.
425 East Greenway Drive
Tempe, AZ 85282-6938
480 456 1010
April 17, 2006

Reference: Mining Claim AZA33385 (Blue Owl)

A check for the annual maintenance fee is enclosed.

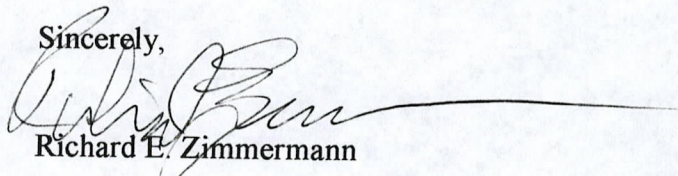
Sincerely,

Richard E. Zimmermann

NO AMC serial # furnished?
Accounts
AMC 368687

RECEIVED
BUREAU OF
LAND MANAGEMENT
2006 APR 20 P 2:47
ARIZONA
STATE OFFICE
PHOENIX, ARIZONA

ENTERED INTO COMPUTER
5/2/06 AB

United States Department of the Interior
Bureau of Land Management
 BUSINESS & SUPPORT SVCS DIV
 ONE N CENTRAL AVE
 PHOENIX, AZ 85004 -2203
 Phone: (602) 417-9200

Receipt

No: 1269563

Transaction #: 1312908	
Date of Transaction: 04/21/2006	
CUSTOMER:	ZERAD INC 425 E GREENWAY DR TEMPE,AZ 85282

LINE #	QTY	DESCRIPTION	REMARKS	UNIT PRICE	TOTAL
1	1.00	LOCATABLE MINERALS / MINING CLAIMS-NOT NEW-UNADJUD,ONE AUTH NO. ONLY / MINING CLAIM MONEY RECEIVED (455) CASES: AMC368687/\$125.00	MAIN 2007 (1)	- n/a -	125.00
TOTAL:					\$125.00

PAYMENT INFORMATION					
1	AMOUNT:	\$125.00	POSTMARKED:	04/19/2006	
	TYPE:	CHECK	RECEIVED:	04/20/2006	
	CHECK NO:	177			
	NAME:	ZERAD INC 425 E GREENWAY DR TEMPE AZ 85282			

REMARKS
ATTENTION: MAKE SURE THAT THE MINING CLAIM SERIAL NUMBER IS INCLUDED. IE AMC AND THE NUMBER.

This receipt was generated by the automated BLM Collections and Billing System and is a paper representation of a portion of the official electronic record contained therein.

Army

Dec 21, 2005

MAIL ROOM

2005 DEC 22 P 2:12

BLM
BLM
STATE OFFICE
PHOENIX, ARIZONA

BLM

Reference: AMC 368687 Blue Owl claim.

Receipt 1202104

your undated letter regarding fees

A check for the additional \$5
is enclosed.

Richard E Zimmerman

Richard Zimmerman

480 456 1010

ENTERED INTO COMPUTER

1/3/06 AB

SENDER: COMPLETE THIS SECTION

- Complete items 1, 2, and 3. Also complete item 4 if Restricted Delivery is desired.
- Print your name and address on the reverse so that we can return the card to you.
- Attach this card to the back of the mailpiece, or on the front if space permits.

1. Article Addressed to:

Zevad
425 E Greenway
Tempe AZ 85282

2. Article Number

(Transfer from service label)

7005 1160 0003 7582 6726

COMPLETE THIS SECTION ON DELIVERY

A. Signature

X *McZimmerman* Agent Addressee

B. Received by (Printed Name)

McZimmerman

C. Date of Delivery

*12-20-05*D. Is delivery address different from item 1? YesIf YES, enter delivery address below: No

3. Service Type

- Certified Mail Express Mail
 Registered Return Receipt for Merchandise
 Insured Mail C.O.D.

4. Restricted Delivery? (Extra Fee)

 Yes

UNITED STATES POSTAL SERVICE

PHOENIX, AZ 850
20 DEC 2005 PM 9 L



First-Class Mail
Postage & Fees Paid
USPS
Permit No. G-10

- Sender: Please print your name, address, and ZIP+4 in this box •

U.S. Department of the Interior
 Bureau Of Land Management
 Arizona State Office
 One North Central Avenue
 Phoenix, AZ 85004-4427

STATE OF ARIZONA
 PHOENIX OFFICE
 PHOENIX, ARIZONA

2005 DEC 21 P

Amy Bunda

LAND MANAGEMENT

4 0041



Amy

**United States Department of the Interior
Bureau of Land Management**

BUSINESS & SUPPORT SVCS DIV
ONE N CENTRAL AVE
PHOENIX, AZ 85004 -2203
Phone: (602) 417-9200

Receipt	
No:	1207434

Transaction #: 1248063
Date of Transaction: 12/23/2005

CUSTOMER:	ZERAD INC 425 E GREENWAY DR TEMPE,AZ 85282
------------------	--------------------------------------------------

LINE #	QTY	DESCRIPTION	REMARKS	UNIT PRICE	TOTAL
1	1.00	LOCATABLE MINERALS / MINING CLAIMS-NOT NEW-UNADJUD,ONE AUTH NO. ONLY / MINING CLAIM MONEY RECEIVED (455) CASES: AMC368687/\$5.00	SUPPL PYMNT	- n/a -	5.00
TOTAL:					\$5.00

PAYMENT INFORMATION																	
1	<table border="1"> <tr><td>AMOUNT:</td><td>\$5.00</td><td>POSTMARKED:</td><td>12/21/2005</td></tr> <tr><td>TYPE:</td><td>CHECK</td><td>RECEIVED:</td><td>12/22/2005</td></tr> <tr><td>CHECK NO:</td><td>173</td><td></td><td></td></tr> <tr><td>NAME:</td><td>ZERAD INC. 425 E GREENWAY DR TEMPE AZ 85282</td><td></td><td></td></tr> </table>	AMOUNT:	\$5.00	POSTMARKED:	12/21/2005	TYPE:	CHECK	RECEIVED:	12/22/2005	CHECK NO:	173			NAME:	ZERAD INC. 425 E GREENWAY DR TEMPE AZ 85282		
AMOUNT:	\$5.00	POSTMARKED:	12/21/2005														
TYPE:	CHECK	RECEIVED:	12/22/2005														
CHECK NO:	173																
NAME:	ZERAD INC. 425 E GREENWAY DR TEMPE AZ 85282																

REMARKS
SEE RECEIPT 1202104/AB

This receipt was generated by the automated BLM Collections and Billing System and is a paper representation of a portion of the official electronic record contained therein.

~~394 code entered to earn additional \$5.00~~

Amy

**United States Department of the Interior
Bureau of Land Management**

BUSINESS & SUPPORT SVCS DIV
ONE N CENTRAL AVE
PHOENIX, AZ 85004 -2203
Phone: (602) 417-9200

Receipt	
No:	1202104

Transaction #: 1242551
Date of Transaction: 12/15/2005
CUSTOMER: ZERAD INC 425 E GREENWAY DR TEMPE, AZ 85282

LINE #	QTY	DESCRIPTION	REMARKS	UNIT PRICE	TOTAL
1	1.00	LOCATABLE MINERALS / MINING CLAIMS-NEW, UNADJUD, ONE OR MORE AUTH NOS / NEW MINING CLAIM LOCATION FEE \$25 (1993) CASES: AMC368687/\$25.00		- n/a -	25.00
2	1.00	LOCATABLE MINERALS / MINING CLAIMS-NEW, UNADJUD, ONE OR MORE AUTH NOS / NEW MINING CLM MAINT FEE \$125 (1993) CASES: AMC368687/\$125.00		- n/a -	125.00
3	1.00	LOCATABLE MINERALS / MINING CLAIMS-NEW, UNADJUD, ONE OR MORE AUTH NOS / NEW MINING CLAIM PROCESSING FEE \$15 (1930) CASES: AMC368687/\$15.00		- n/a -	15.00
TOTAL:					\$165.00

PAYMENT INFORMATION			
1	AMOUNT:	\$165.00	POSTMARKED: 12/05/2005
	TYPE:	CHECK	RECEIVED: 12/12/2005
	CHECK NO:	172	
	NAME:	ZERAD INC 425 E GREENWAY DR TEMPE AZ 85282	

REMARKS
NOTICE SENT

This receipt was generated by the automated BLM Collections and Billing System and is a paper representation of a portion of the official electronic record contained therein.

NOTICE!!

These documents have been scanned!

Do not place un-scanned documents beneath this notice!

Do not remove this notice from this file!

GPO Jacket No. 560-102
Print Order 61540
Rise Business Services, LLC
Job=AZ15 6/3/2019



Box Number= AZ15109



Claim Begin-End: AMC368687-AMC368687

5 Miscellaneous



AZ15109-2

AMC368661-AMC368895

**NO
DOCUMENTS
FOUND**

NO DOCUMENTS FOUND
NO DOCUMENTS FOUND

NOTICE!!

These documents have been scanned!

Do not place un-scanned documents beneath this notice!

Do not remove this notice from this file!

GPO Jacket No. 560-102
Print Order 61540
Rise Business Services, LLC
Job=AZ15 6/3/2019



Box Number= AZ15109



Claim Begin-End: AMC368687-AMC368687

6 Location Notices-Amendments and Supporting Documents



AZ15109-2 AMC368661-AMC368895

MINING CLAIM STATUS REPORT

STATUS:
MTP CHECKED BY _____
GEO CHECKED BY _____
PRE-ADJ BY _____
FINAL ADJ BY _____

LEAD SERIAL NO. AMC 368687 THROUGH AMC _____

	PRIOR TO 12/8/04 = \$165	AFTER 12/8/04 = \$135
# <u>1</u> LODE	LOC @ \$30 = \$ _____	@ \$25 = _____
# _____ PLACER	SER @ \$10 = \$ _____	@ \$10 = _____
# _____ ASSOCIATION PL	MAIN @ \$125 = \$ _____	@ \$100 = _____
# _____ MILL SITE	OVERAGE \$ _____	
# _____ TUNNEL SITE	SHORTAGE \$ _____	
	OTHER FEES \$ _____	
	TOTAL \$ _____	<u>165</u>

OVER-THE-COUNTER MAIL TIMELY FILED: YES NO

LEGAL DESCRIPTION: T 8N R 4W SEC 23

T _____ R _____ SEC _____

T _____ R _____ SEC _____

T _____ R _____ SEC _____

JURISDICTION: BLM FOREST SERVICE

WILDERNESS AREA: NO YES

SPLIT ESTATE: SX PX SRHA OTHER N/A

PROPER NOTICE FILED IF LOCATED ON SRHA LANDS: YES NO N/A

RECONVEYED MINERALS ON BLM LANDS REQUIRE OPENING ORDERS FROM 1944 TO 1993. OPEN TO ENTRY ON: _____

SUBJECT TO PL 359: YES NO

STATUS; VOID PARTIALLY VOID PRIVATE MINERALS

WITHDRAWN LANDS OTHER

CLAIMANT ACKNOWLEDGES THAT PORTIONS OF THE FOLLOWING CLAIM(S)/SITE(S): _____

MAY BE VOID OR VOIDABLE. Signature of Claimant: _____

COMMENTS: _____

LOCATION NOTICE FOR LODE MINING CLAIM

NOTICE IS HEREBY GIVEN that the Blue Owl
_____ lode mining claim has been located
by Zerad, Inc. whose current mailing
address is 425 E. Greenway Dr.
Tempe, AZ 85282

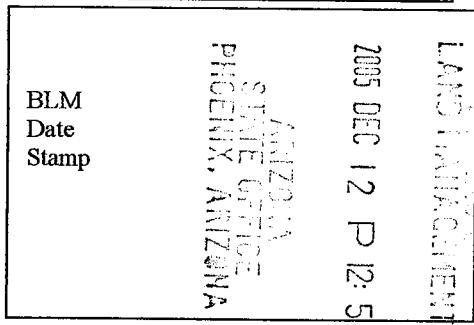

The general course of this claim is EAST TO WEST and it is situated in Yavapai
County, Arizona. This claim is 1160 feet in length and 200 feet in width. This claim runs
from the location monument on which this location notice is posted approximately 40 feet in a
E direction to the E end line and 1120 feet in a W direction to the
W end line. This claim is marked by six monuments, one at each corner and one at the center of each
end line of the claim.

The location monument on which this notice is posted is situated within Section 23, Township 8N
4W, Range 4W, Gila Salt River Base and Meridian, Arizona and this claim encompasses portions
of the following quarter section (s), section (s), Township (s) and Range (s) NW 1/4 AND
SW 1/4 of SECTION 23 T8N R4W

Gila Salt River Base and Meridian, Arizona.

The locality of this claim with reference to some natural object or permanent monument and additional information
(if any) concerning its locality are as follows: 1.29 miles at 217 degrees
from the intersection of Constellation
Road and Blue Tank Wash

DATED AND POSTED on the ground this 3rd day of December, 2005

LOCATOR (s) Richard E. Zimmermann

Form MCF100
Revised July 2005

ARC 348981

MINING CLAIM MAP

Lode () Placer ()

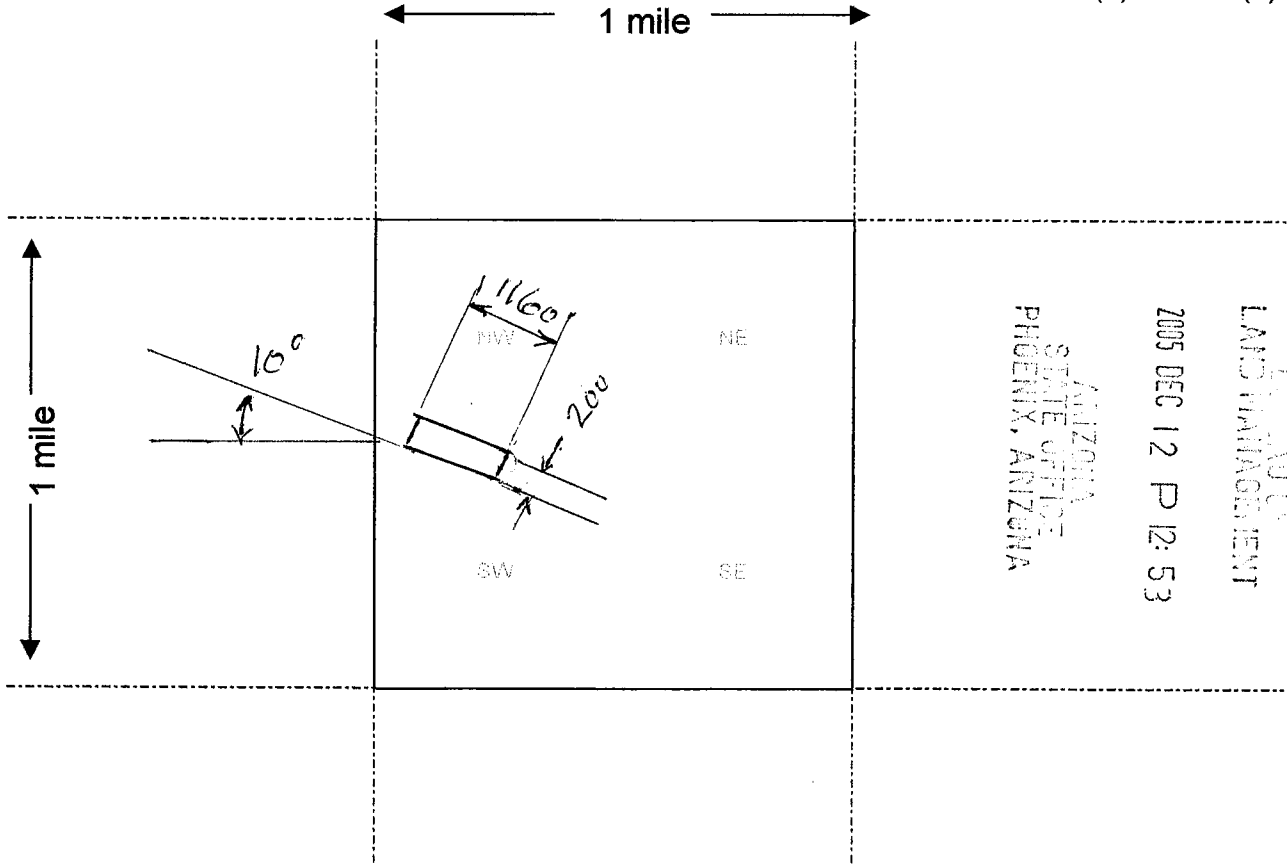

RECEIVED
 ARIZONA
 STATE OFFICE
 PHOENIX, ARIZONA
 2005 DEC 12 P 12:53
 LAND MANAGEMENT

AMB 368687

Scale: 1" = 2000 feet



1. The above map depicts the Blue Owl mining claim, which is located in Section (s) 23, Township 8 N, Range 4 W, Gila and Salt River Base and Meridian, Yavapai County, Arizona.
2. The type of corner and location monuments used are as follows: 1 1/2 INCH WHITE PVC PIPE
3. The bearings and distances in degrees and feet between claim corners are as depicted on the map.

Form MCF100a
 Revised July 2005

This form is available from the **Arizona Department of Mines & Mineral Resources** and may be reproduced.

Monument AT 34 01.225 N 112 38.690 W



Arizona

Bureau of Land Management BLM Offices & Centers
Public Lands USA U.S. Share Appreciation

Home | News | Information | Outdoor Recreation | What We Do | Office Locations

Quick Links

- About BLM Arizona
- Browse this Site
- Cadastral Survey
- Comments
- Cultural Resources
- Employment
- Environmental Education
- FAQs
- Fire & Aviation
- GIS
- Grazing & Range
- Information Access Center
- Lands & Realty
- Land Use Planning
- Maps, Plats, GPS Data
- Minerals & Mining
- National Conservation Areas
- National Monuments
- Policy & Directives
- Recreation
- Resource Advisory Council
- What We Do
- Wild Horses & Burros
- Wilderness Areas
- Wildlife

FIRSTGOV

Annual Mining Claim Filing Requirements Assessment Year 2005

IMPORTANT NOTICE!

INCREASE IN ANNUAL MAINTENANCE FEES AND MINING CLAIM LOCATIONS FEES HAS BEEN RESTORED

- The annual maintenance fees for mining claims, due to BLM on or before September 1, 2005, have increased from \$100 to \$125 per claim.
- The location fee for new mining claims has also increased from \$25 to \$30. Any new mining claims recorded with the BLM on or after June 30, 2005, will cost \$165 per claim. This includes a \$30 location fee, \$125 maintenance fee, and \$10 service charge.
- On July 1, 2004, the Department of the Interior adjusted the location and maintenance fees for mining claims and sites based upon the consumer Price Index (CPI), as required by the Mining Law. See 69 FR 40, 294.
- The Interior and Related Agencies Appropriations Act for fiscal year 2005, Division E, Title I, Section 120 of Public Law 108-447 of December 8, 2004, directed the Department of the Interior to roll back these location and maintenance fees for mining claims and sites to their pre-July 2004 levels. However, the Appropriations Act also provided that the fees would return to their formerly increased levels when BLM had met certain conditions.
- These conditions have now been met and the fees have returned to the levels that are reflected in the regulations found at 43 CFR 3830.21. See 70 FR 38192 dated July 1, 2005.

The current assessment year began **12 noon September 1 2004**, and ends **12 noon September 1, 2005**.

Every year you must file either a **Claim Maintenance Fee** or a **Maintenance Fee Waiver Certificate** (Waiver).

Input Parameters for Geographic Report with Land

System Id = CR

Admin State = AZ

Geo State = AZ

Casetype Begins With

Case Disp Txt = AUTHORIZED, CANCELLED, EXPIRED, PENDING, REJECTED, RELINQUISHED, WITHDRAWN

Mer Twp Rng =

Section =

Mtrs = 14 0080N 0040W 023

Commodity =

Commodity Txt =

Pending Org =

Pend Org Decode =

Total Rows Returned: 1

RUN TIME: 06:31 AM

Adm State: AZ

UNITED STATES DEPARTMENT OF INTERIOR
BUREAU OF LAND MANAGEMENT
GEOGRAPHIC REPORT WITH LAND
Sorted by Meridian Township Range

RUN DATE: 12/22/2005

Page 1 of 1

Serial Number: AZA 033310

Total Case Acres: 1.000

<u>Casetype</u>	<u>Case Disp</u>				<u>Sect</u>	<u>Sur Typ</u>	<u>Sur Num</u>	<u>Suff</u>	<u>Subdivision</u>	<u>Act Pend</u>
380913	PENDING	14	0080N	0040W	023	FF			W2;	

